

Article number: 201056300
Description: E+G Handwheel
GN 949-125-K14-A

Measures

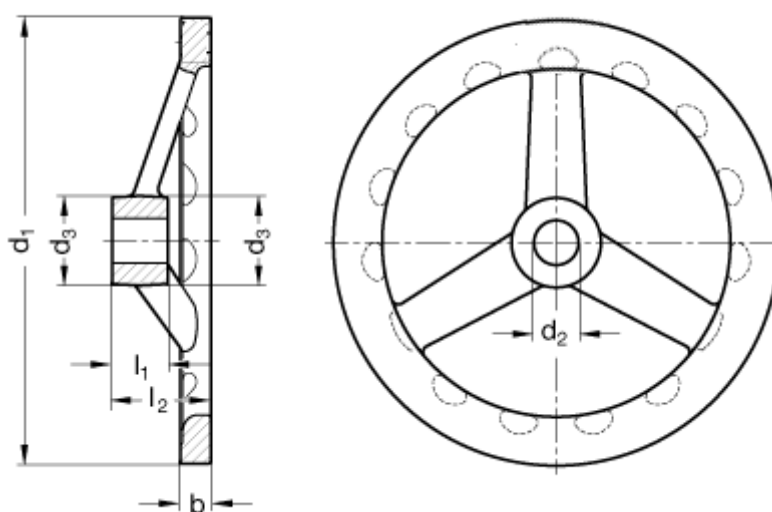

A/F = 9
b = 9
d1 = 125
d2 = 14
d3 = 24
l1 = 16
l2 = 28,5
l3 = 55

Number of spokes = 3